

## 74VHC157 Quad 2-Input Multiplexer

### General Description

The VHC157 is an advanced high speed CMOS Quad 2-Channel Multiplexer fabricated with silicon gate CMOS technology. It achieves the high speed operation similar to equivalent Bipolar Schottky TTL while maintaining the CMOS low power dissipation.

It consists of four 2-input digital multiplexers with common select and enable inputs. When the  $\overline{\text{ENABLE}}$  input is held "H" level, selection of data is inhibited and all the outputs become "L" level. The SELECT decoding determines whether the  $I_{0x}$  or  $I_{1x}$  inputs get routed to their corresponding outputs.

An Input protection circuit ensures that 0V to 7V can be applied to the input pins without regard to the supply volt-

age. This device can be used to interface 5V to 3V systems and on two supply systems such as battery back up. This circuit prevents device destruction due to mismatched supply and input voltages.

### Features

- High Speed:  $t_{PD} = 4.1$  ns (typ) at  $V_{CC} = 5V$
- Low power dissipation:  $I_{CC} = 4$   $\mu A$  (max.) at  $T_A = 25^\circ C$
- High noise immunity:  $V_{NIH} = V_{NIL} = 28\%$   $V_{CC}$  (min.)
- Power down protection is provided on all inputs
- Low noise:  $V_{OLP} = 0.8V$  (max.)
- Pin and function compatible with 74HC157

### Ordering Code:

Order Number	Package Number	Package Description
74VHC157M	M16A	16-Lead Small Outline Integrated Circuit (SOIC), JEDEC MS-012, 0.150" Narrow
74VHC157SJ	M16D	16-Lead Small Outline Package (SOP), EIAJ TYPE II, 5.3mm Wide
74VHC157MTC	MTC16	16-Lead Thin Shrink Small Outline Package (TSSOP), JEDEC MO-153, 4.4mm Wide
74VHC157N	N16E	16-Lead Plastic Dual-In-Line Package (PDIP), JEDEC MS-001, 0.300" Wide

Surface mount packages are also available on Tape and Reel. Specify by appending the suffix letter "X" to the ordering code.

### Logic Symbols

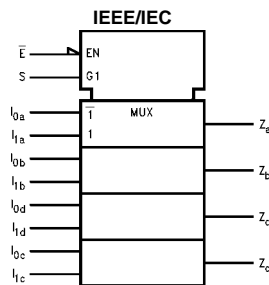
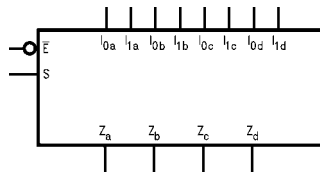

### Connection Diagram

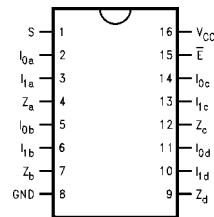

### Pin Descriptions

Pin Names	Description
$I_{0a}-I_{0d}$	Source 0 Data Inputs
$I_{1a}-I_{1d}$	Source 1 Data Inputs
$\overline{\text{E}}$	Enable Input
S	Select Input
$Z_a-Z_d$	Outputs

**Truth Table**

Inputs				Outputs
$\bar{E}$	S	I <sub>0</sub>	I <sub>1</sub>	Z
H	X	X	X	L
L	H	X	L	L
L	H	X	H	H
L	L	L	X	L
L	L	H	X	H

H = HIGH Voltage Level  
 L = LOW Voltage Level  
 X = Immaterial

**Functional Description**

The VHC157 is a quad 2-input multiplexer. It selects four bits of data from two sources under the control of a common Select input (S). The Enable input ( $\bar{E}$ ) is active-LOW. When  $\bar{E}$  is HIGH, all of the outputs (Z) are forced LOW regardless of all other inputs. The VHC157 is the logic implementation of a 4-pole, 2-position switch where the position of the switch is determined by the logic levels supplied to the Select input. The logic equations for the outputs are shown below:

$$Z_a = \bar{E} \cdot (I_{1a} \cdot S + I_{0a} \cdot \bar{S})$$

$$Z_b = \bar{E} \cdot (I_{1b} \cdot S + I_{0b} \cdot \bar{S})$$

$$Z_c = \bar{E} \cdot (I_{1c} \cdot S + I_{0c} \cdot \bar{S})$$

$$Z_d = \bar{E} \cdot (I_{1d} \cdot S + I_{0d} \cdot \bar{S})$$

A common use of the VHC157 is the moving of data from two groups of registers to four common output busses. The particular register from which the data comes is determined by the state of the Select input. A less obvious use is as a function generator. The VHC157 can generate any four of the sixteen different functions of two variables with one variable common. This is useful for implementing gating functions.

**Logic Diagram**

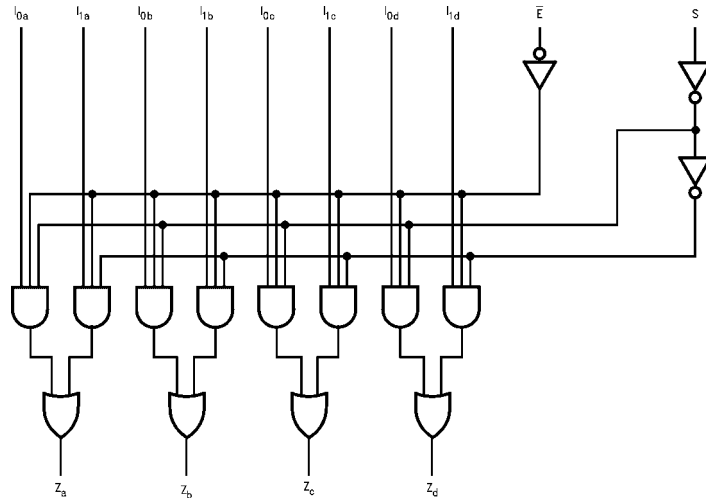

Please note that this diagram is provided only for the understanding of logic operations and should not be used to estimate propagation delays.

**Absolute Maximum Ratings** (Note 1)

Supply Voltage ( $V_{CC}$ )	-0.5V to +7.0V
DC Input Voltage ( $V_{IN}$ )	-0.5V to +7.0V
DC Output Voltage ( $V_{OUT}$ )	-0.5V to $V_{CC} + 0.5V$
Input Diode Current ( $I_{IK}$ )	-20 mA
Output Diode Current ( $I_{OK}$ )	$\pm 20$ mA
DC Output Current ( $I_{OUT}$ )	$\pm 25$ mA
DC $V_{CC}/GND$ Current ( $I_{CC}$ )	$\pm 50$ mA
Storage Temperature ( $T_{STG}$ )	-65°C to +150°C
Lead Temperature ( $T_L$ ) (Soldering, 10 seconds)	260°C

**Recommended Operating Conditions** (Note 2)

Supply Voltage ( $V_{CC}$ )	2.0V to +5.5V
Input Voltage ( $V_{IN}$ )	0V to +5.5V
Output Voltage ( $V_{OUT}$ )	0V to $V_{CC}$
Operating Temperature ( $T_{OPR}$ )	-40°C to +85°C
Input Rise and Fall Time ( $t_r, t_f$ )	
$V_{CC} = 3.3V \pm 0.3V$	0 ~ 100 ns/V
$V_{CC} = 5.0V \pm 0.5V$	0 ~ 20 ns/V

**Note 1:** Absolute Maximum Ratings are values beyond which the device may be damaged or have its useful life impaired. The databook specifications should be met, without exception, to ensure that the system design is reliable over its power supply, temperature, and output/input loading variables. Fairchild does not recommend operation outside databook specifications.

**Note 2:** Unused inputs must be held HIGH or LOW. They may not float.

**DC Electrical Characteristics**

Symbol	Parameter	$V_{CC}$ (V)	$T_A = 25^\circ\text{C}$			$T_A = -40^\circ\text{C to } +85^\circ\text{C}$		Units	Conditions			
			Min	Typ	Max	Min	Max					
$V_{IH}$	HIGH Level	2.0	1.50			1.50		V				
	Input Voltage	3.0 – 5.5	$0.7 V_{CC}$			$0.7 V_{CC}$						
$V_{IL}$	LOW Level	2.0		0.50		0.50		V				
	Input Voltage	3.0 – 5.5		$0.3 V_{CC}$		$0.3 V_{CC}$						
$V_{OH}$	HIGH Level Output Voltage	2.0	1.9	2.0		1.9		V	$V_{IN} = V_{IH}$ or $V_{IL}$	$I_{OH} = -50 \mu\text{A}$		
		3.0	2.9	3.0		2.9						
		4.5	4.4	4.5		4.4						
		3.0	2.58			2.48						
$V_{OL}$	LOW Level Output Voltage	4.5	3.94			3.80		V	$V_{IN} = V_{IH}$ or $V_{IL}$	$I_{OH} = -4 \text{ mA}$ $I_{OH} = -8 \text{ mA}$		
		2.0		0.0	0.1		0.1					
		3.0		0.0	0.1		0.1					
		4.5		0.0	0.1		0.1					
$V_{OL}$	LOW Level Output Voltage	3.0			0.36		0.44	V	$V_{IN} = V_{IH}$ or $V_{IL}$	$I_{OL} = 4 \text{ mA}$ $I_{OL} = 8 \text{ mA}$		
		4.5			0.36		0.44					
		0 – 5.5			$\pm 0.1$		$\pm 1.0$				$\mu\text{A}$	$V_{IN} = 5.5V$ or GND
		$I_{IN}$	Input Leakage Current									
$I_{CC}$	Quiescent Supply Current	5.5			4.0		40.0	$\mu\text{A}$	$V_{IN} = V_{CC}$ or GND			

**Noise Characteristics**

Symbol	Parameter	$V_{CC}$ (V)	$T_A = 25^\circ\text{C}$		Units	Conditions
			Typ	Limits		
$V_{OLP}$ (Note 3)	Quiet Output Maximum Dynamic $V_{OL}$	5.0	0.3	0.8	V	$C_L = 50 \text{ pF}$
$V_{OLV}$ (Note 3)	Quiet Output Minimum Dynamic $V_{OL}$	5.0	-0.3	-0.8	V	$C_L = 50 \text{ pF}$
$V_{IHD}$ (Note 3)	Minimum HIGH Level Dynamic Input Voltage	5.0		3.5	V	$C_L = 50 \text{ pF}$
$V_{ILD}$ (Note 3)	Maximum LOW Level Dynamic Input Voltage	5.0		1.5	V	$C_L = 50 \text{ pF}$

**Note 3:** Parameter guaranteed by design.

## AC Electrical Characteristics

Symbol	Parameter	V <sub>CC</sub> (V)	T <sub>A</sub> = 25°C			T <sub>A</sub> = -40°C to +85°C		Units	Conditions
			Min	Typ	Max	Min	Max		
t <sub>PLH</sub>	Propagation Delay I <sub>n</sub> to Z <sub>n</sub>	3.3 ± 0.3	6.2	9.7	1.0	11.5	ns	C <sub>L</sub> = 15 pF	
t <sub>PHL</sub>			8.7	13.2	1.0	15.0		C <sub>L</sub> = 50 pF	
		5.0 ± 0.5	4.1	6.4	1.0	7.5	ns	C <sub>L</sub> = 15 pF	
			5.6	8.4	1.0	9.5		C <sub>L</sub> = 50 pF	
t <sub>PLH</sub>	Propagation Delay S to Z <sub>n</sub>	3.3 ± 0.3	8.4	13.2	1.0	15.5	ns	C <sub>L</sub> = 15 pF	
t <sub>PHL</sub>			10.9	16.7	1.0	19.0		C <sub>L</sub> = 50 pF	
		5.0 ± 0.5	5.3	8.1	1.0	9.5	ns	C <sub>L</sub> = 15 pF	
			6.8	10.1	1.0	11.5		C <sub>L</sub> = 50 pF	
t <sub>PLH</sub>	Propagation Delay E to Z <sub>n</sub>	3.3 ± 0.3	8.7	13.6	1.0	16.0	ns	C <sub>L</sub> = 15 pF	
t <sub>PHL</sub>			11.2	17.1	1.0	19.5		C <sub>L</sub> = 50 pF	
		5.0 ± 0.5	5.6	8.6	1.0	10.0	ns	C <sub>L</sub> = 15 pF	
			7.1	10.6	1.0	12.0		C <sub>L</sub> = 50 pF	
C <sub>IN</sub>	Input Capacitance		4	10		10	pF	V <sub>CC</sub> = Open	
C <sub>PD</sub>	Power Dissipation Capacitance		20				pF	(Note 4)	

**Note 4:** C<sub>PD</sub> is defined as the value of the internal equivalent capacitance which is calculated from the operating current consumption without load. Average operating current can be obtained by the equation: I<sub>CC (opr.)</sub> = C<sub>PD</sub> \* V<sub>CC</sub> \* f<sub>IN</sub> + I<sub>CC</sub>.

**Physical Dimensions** inches (millimeters) unless otherwise noted

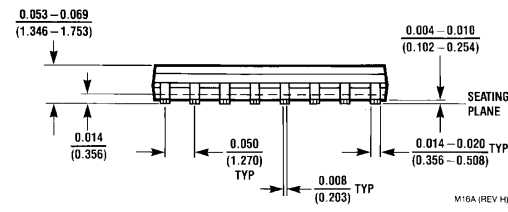
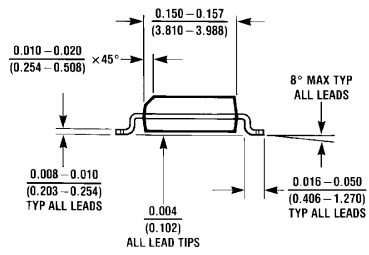
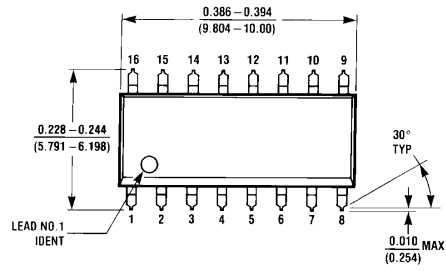

**16-Lead Small Outline Integrated Circuit (SOIC), JEDEC MS-012, 0.150" Narrow  
Package Number M16A**

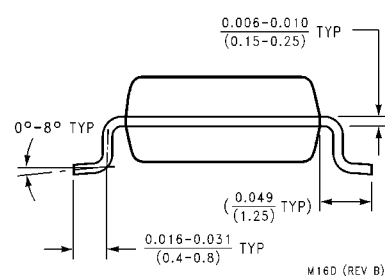
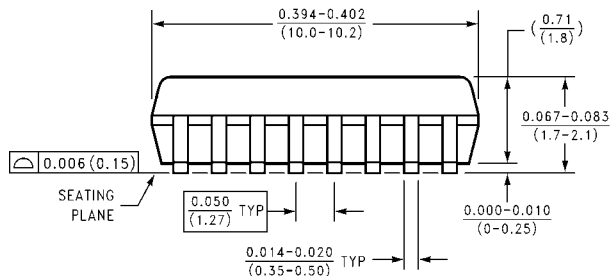
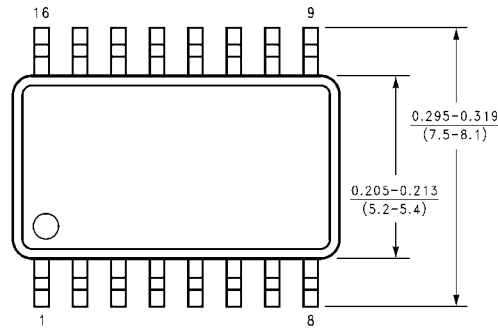

**16-Lead Small Outline Package (SOP), EIAJ TYPE II, 5.3mm Wide  
Package Number M16D**

**Physical Dimensions** inches (millimeters) unless otherwise noted (Continued)

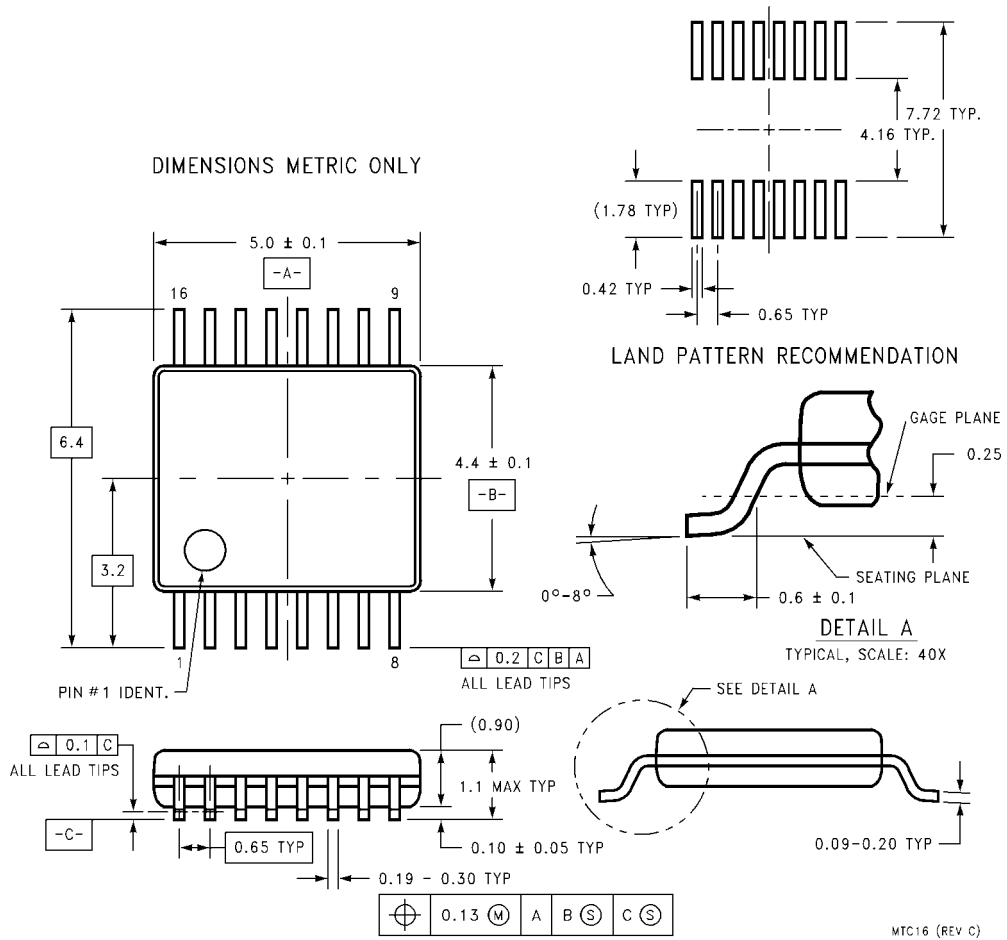

**16-Lead Thin Shrink Small Outline Package (TSSOP), JEDEC MO-153, 4.4mm Wide  
Package Number MTC16**

MTC16 (REV C)

**Physical Dimensions** inches (millimeters) unless otherwise noted (Continued)



**16-Lead Plastic Dual-In-Line Package (PDIP), JEDEC MS-001, 0.300" Wide Package Number N16E**

**LIFE SUPPORT POLICY**

FAIRCHILD'S PRODUCTS ARE NOT AUTHORIZED FOR USE AS CRITICAL COMPONENTS IN LIFE SUPPORT DEVICES OR SYSTEMS WITHOUT THE EXPRESS WRITTEN APPROVAL OF THE PRESIDENT OF FAIRCHILD SEMICONDUCTOR CORPORATION. As used herein:

1. Life support devices or systems are devices or systems which, (a) are intended for surgical implant into the body, or (b) support or sustain life, and (c) whose failure to perform when properly used in accordance with instructions for use provided in the labeling, can be reasonably expected to result in a significant injury to the user.
2. A critical component in any component of a life support device or system whose failure to perform can be reasonably expected to cause the failure of the life support device or system, or to affect its safety or effectiveness.

[www.fairchildsemi.com](http://www.fairchildsemi.com)